



KONICA MINOLTA

AccurioPress  
C7100/C7090

# MAKE A POWERFUL IMPRESSION

## RETHINK AGILITY

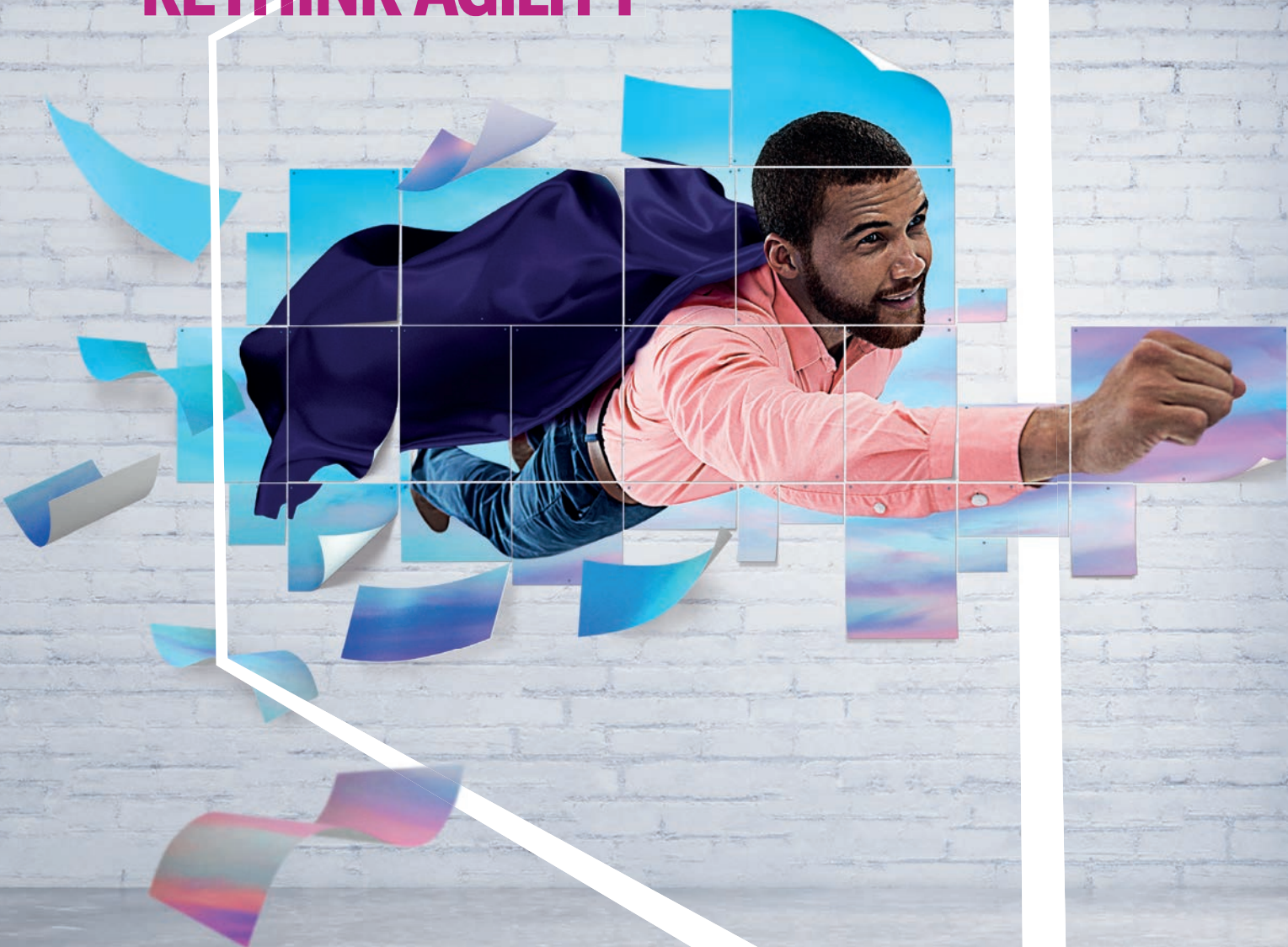

Giving Shape to Ideas

# DISCOVER AGILITY THAT CREATES OPPORTUNITY

More profitable business through a press that works smarter not harder – this was key in the development of AccurioPress C7100 and AccurioPress C7090. With a focus on optimizing performance, offering new and advanced print products, and growing the entire business. With the AccurioPress C7100 series, you serve more customers and complete more jobs with innovative technologies that power your success.

## INTELLIGENT AUTOMATION

By instantly detecting the precise stock you're using, the optional Intelligent Media Sensor IM-101 significantly reduces production time. At the same time, the optional Intelligent Quality Optimiser IQ-501 ensures perfectly consistent colour quality and front-to-back registration on every print in real time. And as there's no recalibrations or inspections mid-run, you'll benefit from improved productivity as well.

## ENHANCED FINISHING

The optional in-line TU-510 4-edge trimming unit cuts, creases and perforates to produce stunning full-bleed trimmed book jackets, imposed cards, business cards, coupons and more. Removing the need for off-line finishing means fewer operator touchpoints for faster and more efficient print runs.

## FLAWLESS QUALITY

Our latest Simitri V toner is eco-friendly and formulated for performance. Fast melting, energy efficient and low maintenance, it reproduces superb quality on a wider range of media up to 400 g/m<sup>2</sup>. Combined with an output resolution of 3,600 dpi equivalent x 2,400 dpi, you will get outstanding results even from the fastest, longest print runs.

## ADVANCED CAPABILITIES

With auto-duplex banners up to 900mm and the flexibility to handle embossed and textured media, its handling so simple that one operator can run even the most complex projects. So, why not say yes right now to more opportunities that will grow your business!

## EXCEPTIONAL DURABILITY

Reliability drives profitability. Among the new technologies built into the engine are a more durable lubricated drum, double corona wires with automatic cleaning, an optimized paper transport solution, and a double swing registration system for improved paper compatibility and feeding accuracy.

# INNOVATE PRINT RETHINK TECHNOLOGY

## Intelligent Quality Optimiser IQ-501

The Intelligent Quality Optimiser IQ-501 takes color consistency and registration accuracy to the next level. With highly automated image registration and color control, a closed-loop system that constantly monitors and adjusts printed output, and automated color calibration and profiling, IQ-501 delivers streamlined operator time, reduced print waste, and industry-leading productivity!

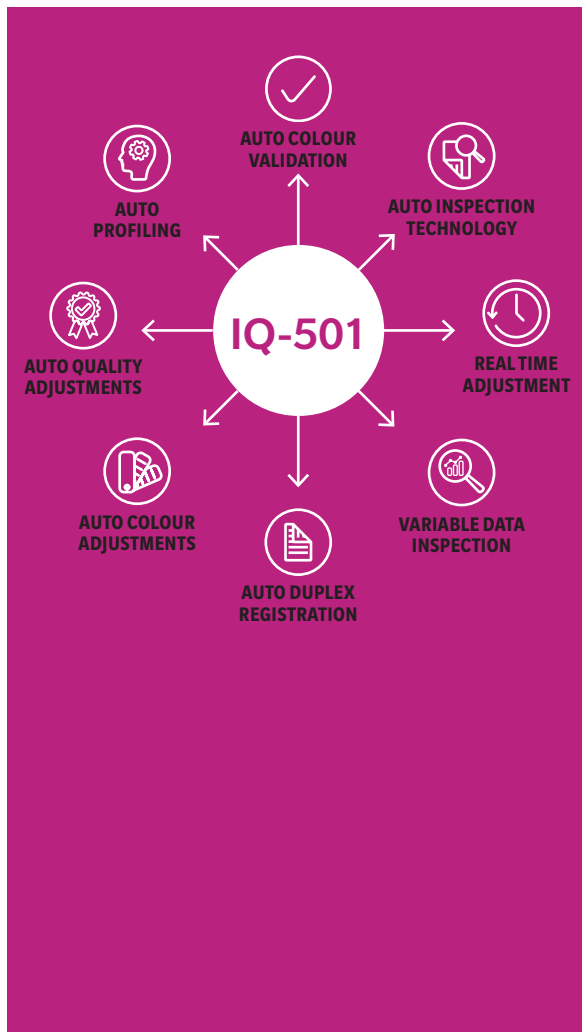

## Simitri<sup>®</sup> V

### Simitri<sup>®</sup> V Toner

Konica Minolta's innovative Toner technology Simitri<sup>®</sup> V gives superb print quality and an offset matte finish. Furthermore it supports the high productivity of AccurioPress C7100 series and it requires a lower fusing temperature which reduces the energy consumption of the system and the impact of the printing process on the paper. Simitri V was designed to easily follow the surface of the paper or substrate to guarantee best possible print quality on embossed, structured or recycled materials.

### S.E.A.D. X Image Processing

Konica Minolta's own advanced colour processing technology of the fifth generation is called S.E.A.D. X, which stands for "Screen-Enhancing Active Digital Process", and combines an array of technical innovations to guarantee truly exceptional colour reproduction at top speed.

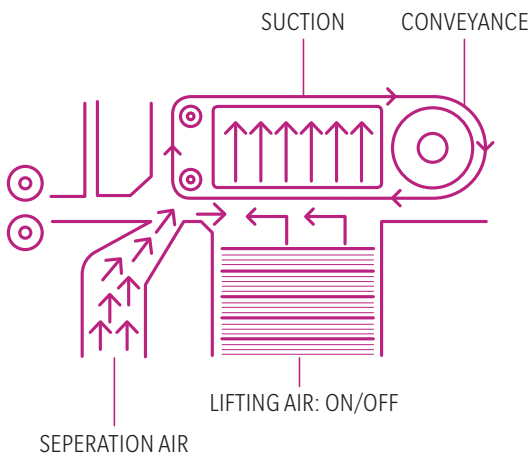

### Vacuum paper feeding

It is essential for high-volume printers to feed each and every sheet smoothly and precisely through the digital press. To ensure this, Konica Minolta offers professional and intelligent paper feeding for all formats up to 900 mm length that builds upon proven concepts, including a combination of air separation of sheets and suction/vacuum feeding. This ensures smooth paper processing throughout the printing system. For efficient printing on offset preprinted and coated stock as well as under high humidity conditions, an optional heating unit can be added to enhance this precise technology further.

### Intelligent Media Sensor

The optional media sensor IM-101 automatically detects the type, weight, thickness and surface of each substrate, and proposes the appropriate paper

settings from the catalogue, which makes wrong paper settings a thing of the past avoiding misprints and waste.

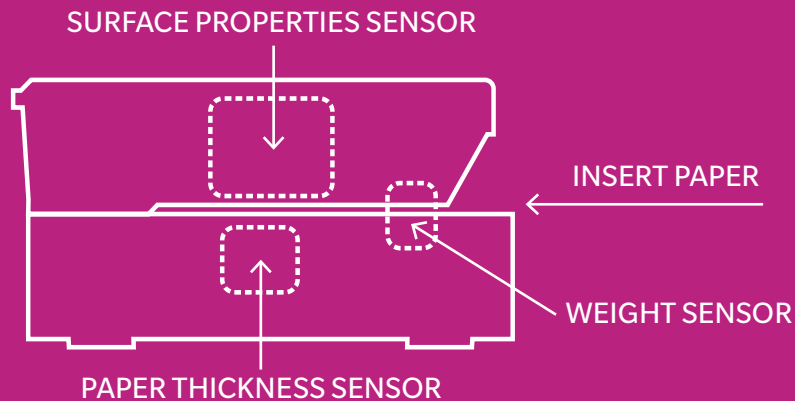

# STATE-OF-THE-ART- PRINT-SERVER RETHINK PRODUCTION PRINTING

## THE IC-609 KONICA MINOLTA OWN CONTROLLER

The Konica Minolta IC-609 print controller brings powerful workflow benefits – including 2,400 dpi printing at full rated engine speed, high-speed RIP processing, enhanced accuracy in colour reproduction, colour management functions and full compatibility with print engine on-board job control and editing functions.

## IC-318L EFI FIERY CONTROLLER

Reduce labour costs, cut turnaround times, and minimize errors and paper waste with the advanced job management and workflow automation that the Fiery® IC-318L provides. Streamline your job layout with the Fiery's instant visual preview and advanced make ready capabilities. What's more, supporting industry-leading variable data printing (VDP) formats, the Fiery also produces personalized short-run jobs profitably.

## IC-319 EFI FIERY CONTROLLER

The top-of-the-line Fiery® IC-319 will improve your bottom line with best-in-class processing, outstanding colour and time-saving workflows. If you want the best out-of-the-box colour consistency and accuracy with powerful colour matching, profiling, and automated calibration, look no further! With EFI™ management information systems and web-to-print solutions, the IC-319 eliminates touch points and optimizes production; plus it integrates with industry-leading prepress workflow solutions.

## IC-316 CREO CONTROLLER

The Creo® IC-316 external print controller supports perfect variable data printing integration and is the ideal choice for hybrid prepress workflows. Beyond that, the Creo features advanced spot colour profiling, a complete Pantone GOE library, Remote Site Manager status tracking, JDF connectivity, Creo job ticket software, and much more.

# STREAMLINE YOUR PRODUCTION

## RETHINK YOUR WORKFLOW

Evolving from our expertise in precision technologies and more than 80 years of experience in the printing and imaging industries, AccurioPro reflects our commitment to developing market-shaping technology with functionality that enables your business to grow. AccurioPro, Konica Minolta's suite of digital solutions for professional printing, is one of the industry's most versatile and powerful tools to optimise print production operations and workflows.

For all printing companies looking to integrate their printing as well as businesses that use digital printing to produce their own in-house publications and

promotional materials, AccurioPro boosts speed and efficiency, expands capabilities and services, and reduces the need for operational manpower – all of which will help improve your profitability!

The comprehensive suite of features that AccurioPro offers includes centralised management, software for automated workflow processing, colour management, seamless integration of different printing technologies and full connectivity of all Konica Minolta printing systems used from input to output.



# YOUR ADVANTAGES WITH THE AccurioPress C7100 / C7090

## RETHINK PRODUCTION PRINTING

### READY-MADE PRINT PRODUCTS

- 50-sheet booklet making with front trimming and optional creasing, slitting and spine corner forming
- Perfect binding for books of up to 30 mm
- 100-sheet stapling with cutting mechanism
- Automated inline business card and postcard cutting
- Full bleed banners, A3 and A4 posters

### DURABLE PERFORMANCE

#### AccurioPress C7100

- Duty Cycle of up to 1.8 million prints
- Up to 100 A4 colour pages per minute
- Up to 53 SRA3 colour pages per minute

#### AccurioPress C7090

- Duty Cycle of up to 1.62 million prints
- Up to 90 A4 colour pages per minute
- Up to 48 SRA3 colour pages per minute

### GEARED-UP FINISHING

- 2- & 4-hole punching
- 6 different types of folding
- Large-capacity stacking
- 2 Perforations in feed direction, 5 Perforations in Cross feed direction
- Up to 5 Creases downwards or upwards

### SIMPLY EFFICIENT

- Automated engine linearisation
- Automated duplex registration
- Automated profiling
- Real-time adjustments
- Purge function

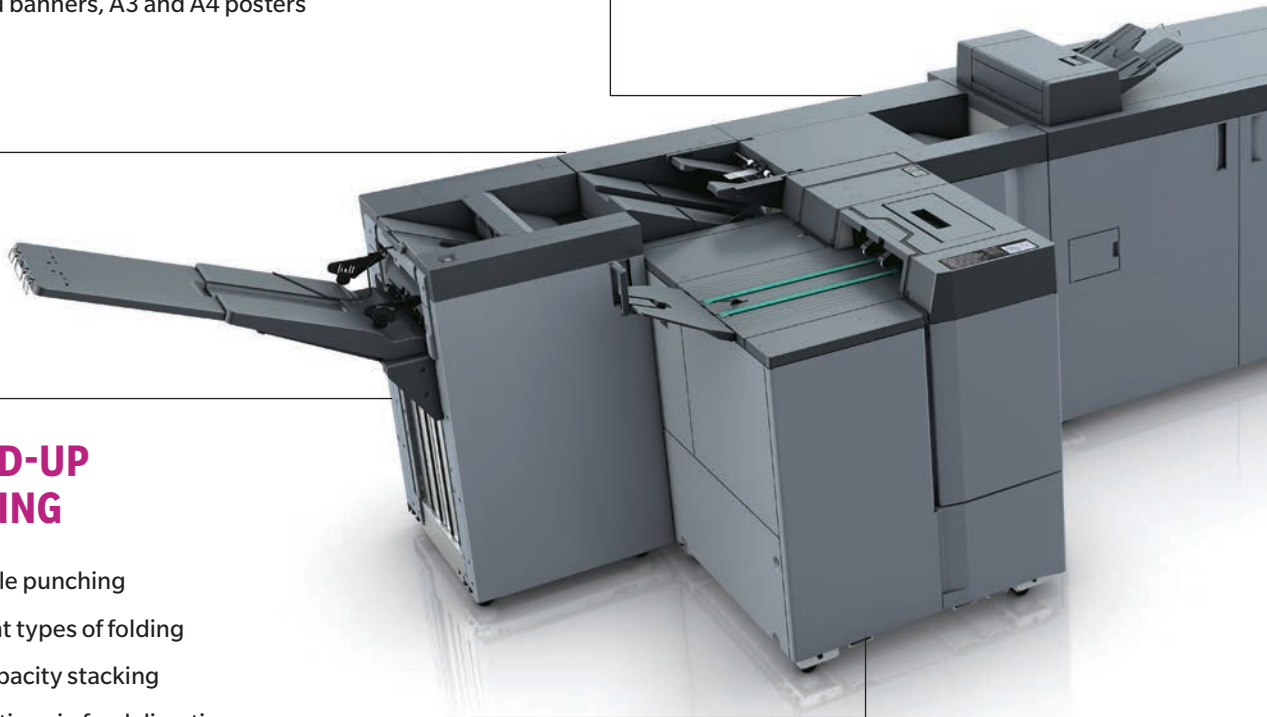



## HIGHEST RELIABILITY

- Long-life platform, long-lasting parts and consumables
- Accurate front to back registration
- For prints with maximum efficiency
- For lucrative short-run printing

## HIGH-END PRINT CONTROL

- Flexible choice of controller technology: EFI®, CREO® or proprietary Konica Minolta controller
- Integration into hybrid workflows

## EASE OF USE

- Simple paper catalogue settings
- Auto Inspection Technology

## PERFECT IMAGE QUALITY

- S.E.A.D. X  
3,600 x 2,400 dpi x 8 bit resolution
- Simitri V toner technology
- Image density control technology

## SOPHISTICATED MEDIA HANDLING













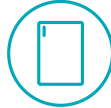











- Automatic media recognition
- Air-suction feeding technology
- Up to 15,150 sheets paper input capacity
- Up to 11 paper input trays
- Up to 2,300 sheets paper input for long sheets (up to 900 mm)

































## COMPREHENSIVE MEDIA PROCESSING

- Up to 400 g/m<sup>2</sup> paper weight in simplex and duplex printing
- Long sheet size of up to 1,300 mm (duplex up to 900 mm)
- Reliable thin paper feeding through air-blow fusing separation
- Envelope printing
- Embossed paper support
- Optional inter-cooler curl eliminator



# FINISHING & FUNCTIONS

		 2/4 hole Punching	 Two-point stapling	 Corner stapling	 Stacking
Open stacker <b>OT-512</b>					
Staple finisher <b>FS-532m</b>					
Staple finisher <b>FS-541</b>					
Booklet making unit <b>SD-513</b>					
Stacking unit <b>LS-507</b>					
Folding and punching unit <b>FD-503</b>					
Perfect binding unit <b>PB-503</b>					
Booklet making unit <b>SD-506</b>					
Trimming unit <b>TU-510</b>					

 Booklet	 Trimming	 Creasing	 Perfection	 Slitting	 Spine Corner Forming	 Three-fold	 Post Insertion	 Perfect Binding
								
								
								
								
								
								
								

# 10 GOOD REASONS FOR AccurioPress C7100 SERIES

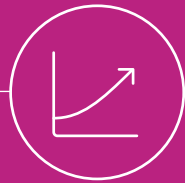

## 1. BUSINESS EXPANSION

Compatible with thin to thick media and superior banner printing capabilities



## 2. INTELLIGENT AUTOMATION

Minimize preparation time with easy and quick setup routines, e.g. for media, colours, registration



## 5. NEW PRINT PRODUCTS

Extend your offerings with textured media, envelope and long sheet duplex printing



## 6. HIGHEST RELIABILITY

Durable design and accurate registration for quality products with minimum waste



### 3. AUTOMATED FINISHING

Many unique inline finishing options to create ready-to-ship booklets, perfect bound books, ring binding, business cards or full bleed banners and many more

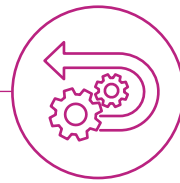

### 4. FAST TURN AROUND

Same high engine performance on all kinds of media combined with closed loop quality control and inspection technology



### 7. SUPERB IMAGE QUALITY

Simitri V, high print resolution and Konica Minolta's very own imaging technology guarantee happy customers



### 8. WORRY-FREE OPERATION

Real-time quality control for consistent and faultless print products



### 9. INCREASED UPTIME

Long-lasting consumables, high paper input capacity and dependable productivity secure uninterrupted production



### 10. EASE OF USE

Even novice operators will get very good and consistent results at the tip of a finger.

# TAKE LEADERSHIP AND RESPONSIBILITY

## RETHINK TOMORROWS BUSINESS

### MADE YOUR BUSINESS

#### Commercial printers

The AccurioPress C7100 series supports you in growing your business and getting the most out of your investment. Its high speed, high productivity and high uptime help you achieve shortest turnaround times, while the great media flexibility with stocks of up to 400 g/m<sup>2</sup>, long sheets of up to 1,300 mm, envelopes and structured media will further enhance the variety of our print offerings. Colour quality issues are a thing of the past as the AccurioPress C7100 includes numerous auto control and adjustment features. What's more, an inspection system can be applied to make sure only impeccable prints leave your shop.

#### CRDs

The AccurioPress C7100 series provides the highest degree of automation and produces quality on the highest level. With its professional inline finishing, you can create ready-made products at the push of a button; and the Intelligent Quality Optimiser IQ-501 makes sure that the print quality is automatically set, monitored and continuously corrected. The versatile media flexibility and high productivity make the AccurioPress C7100 series a solid and lucrative investment for the future.

### DESIGN FOR OUR PLANET

Konica Minolta promotes sustainable development and integrates environmental and social perspectives into its business strategies. You can rely on Konica Minolta products to underpin your green strategy to build your business.

Committed to help prevent global warming, Konica Minolta strives to reduce CO<sub>2</sub> emissions during product manufacture, product distribution, at the sales stage, and during product use – with even stricter targets than demanded by the Kyoto Protocol. Enabling carbon neutrality, Konica Minolta offers its customers the offset of unavoidable CO<sub>2</sub> emissions for production printing. Together with the experts from Climate Partner, Konica Minolta proposes a new and profound eco concept for our professional production presses.





# CONTROLLER AND OPTIONS

## RETHINK THE NEEDS

### FIERY IMAGE CONTROLLER IC-319

Architecture	External
OS	Windows 10
CPU	Intel® Xeon 5118
Clock speed	2.3 GHz
RAM std	32 GB
HDD	4.5 TB
Page-description language	Adobe PostScript 3; PDF v1.7; APPE v5; PDF/VT-1/-2 v3; PDF/X1a,3,4; PPML v3.0; PCL; Creo VPS
Applicable OS	Windows 8.1/10; Windows Server 2012/R2/2016/2019; Mac OS 10.14-10.15, Mac OS 11

### FIERY IMAGE CONTROLLER IC-318L

Architecture	External
OS	Windows 10
CPU	Intel i7-6700
Clock speed	3.4 GHz
RAM std	16 GB
HDD	1 TB
Page-description language	Adobe PostScript 3; PDF v1.7; APPE v5; PDF/VT-1/-2 v3; PDF/X1a,3,4; PPML v3.0; PCL; Creo VPS
Applicable OS	Windows 8.1/10; Windows Server 2012/R2/2016/2019; Mac OS 10.14-10.15, Mac OS 11

### CREO IMAGE CONTROLLER IC-316

Architecture	External
OS	Windows 10
CPU	Intel i7-8700
Clock speed	3.2 GHz
RAM std	20 GB
HDD	8 TB
Page-description language	Adobe PostScript 3; PDF v1.7; APPE v4.9; PDF/VT-1/-2; PDF/X1a,3,4; PPML v2.2; Creo VPS; AFP; IPDS; JPEG; TIFF (v6, 1bit)
Applicable OS	Windows 8.1/10; Windows Server 2012/R2/2016/2019; Mac OS 10.12-15

### KONICA MINOLTA IMAGE CONTROLLER IC-609

Architecture	Internal
OS	Linux
CPU	Intel Core i5 6500
Clock speed	3.2 GHz
RAM std	16 GB
HDD	2 TB (2 x 1TB)
Page-description language	Adobe PostScript 3; APPE (with UK-220); TIFF v6; PDF 1.7, X-1a, X-3, X-4, VT2; PPML 2.2; PCL 5c; XL; PCL XL; JDF/JMF
Applicable OS	Windows 8.1/10; Windows Server 2012/R2/2016/2019; Mac OS 10.12-15, Mac OS 11

### OPTIONS

Internal KM image controller	IC-609
Local connection kit	EK-612
APPE kit	UK-220
HDD kit	UK-112
EFI External image controller	IC-318L ver.1.1
EFI Internal image controller	IC-319 ver.1.1
Creo external image controller	IC-316 ver.1.1
Video interface kit	VI-515
Card authentication equipment	AU-201S
Patlite	MK-744C
Working table	WT-511
Fusing unit for envelopes	EF-108
Option heater	HT-511
Intelligent media sensor	IM-101
High end finisher	FS-541
Entry finisher	FS-532m
Saddle stitcher for FS-541/532m	SD-510
Punch for FS-541/532m	PK-525
PI mount kit for FS-541/532m	MK-732
Post inserter for FS-541/532m	PI-502
Saddle stitcher (50 sheets)	SD-506
Saddle stitcher (50 sheets)	SD-513
Square fold for SD-513	FD-504
Creaser for SD-513	CR-101
Slitter for SD-513	TU-503
Large capacity stacker	LS-507
Carrier for LS-507	LC-502
Trimmer unit	TU-510
Creaser for TU-510	CR-102
Slitter for TU-510	TU-504
Banner unit for TU-510	MK-764
Card unit for TU-510	JS-507
Creaser (upward convex) for TU-510	CR-103
Perforation unit FD for TU-510	PE-101
Perforation unit CD for TU-510	PE-102
Dust box for TU-510	MK-765
Folding unit	FD-503
Perfect binder	PB-503
Open stacker	OT-512
Output tray	OT-511m
Turnover relay unit	RU-510
Hybrid decurler	RU-518m
Humidifier for RU-518m	HM-103
Intelligent Quality Optimiser	IQ-501
Video interface kit	VI-514
Relay conveyance unit	RU-702
Paper inspection unit	UK-301
Paper inspection upgrade board	UK-311
VDP data comparison upgrade kit	UK-312
3-Tray Paper feed unit	PF-712
3-Tray Paper feed unit(Scanner)	PF-713
3-Tray Paper feed unit(Banner)	PF-812
Large capacity tray	LU-208
Large capacity tray(Banner)	LU-208XL
Multi-bypass tray	MB-510
Multi-bypass tray for PF-712/PF-812	MB-511
Intermediate Conveyance Unit	FA-505
Dehumidifier fan heater for -712/PF-713/PF-812	HT-506
Dehumidifier fan heater for LU-208/LU-208XL	HT-515/HT-518
Envelope installation kit	MK-746
Banner input tray unit	MK-760
Banner output tray unit	MK-761





KONICA MINOLTA

# TECHNICAL SPECIFICATIONS

## RETHINK PRODUCTION PRINTING

### SYSTEM SPECIFICATIONS

Resolution	2,400 x 3,600 equiv. dpi x 8 bit
Paper Weight	52–400 g/m <sup>2</sup>
Duplex Unit	Non-stack type; 52–400 g/m <sup>2</sup>
Paper sizes	330.2 x 487.7 mm 330.2 x 900 mm (max. duplex) 330.2 x 1,300 mm (max. simplex)
Paper input capacity	15,140 sheets
Main unit dimensions (W x D x H)	800 x 1,138 x 1,478 mm
Main unit weight	335 kg

### PRODUCTIVITY

#### AccurioPress C7100

A4 colour - max. per minute	100 ppm
A4 mono - max. per minute	110 ppm
SRA3 colour - max. per minute	53 ppm
SRA3 mono - max. per minute	58 ppm
A4 colour - max. per hour	5,613 pph
A4 mono - max. per hour	6,103 pph

#### AccurioPress C7090

A4 colour - max. per minute	90 ppm
A4 mono - max. per minute	110 ppm
SRA3 colour - max. per minute	48 ppm
SRA3 mono - max. per minute	58 ppm
A4 colour - max. per hour	5,047 pph
A4 mono - max. per hour	6,103 pph

- All specifications refer to A4-size paper of 80 g/m<sup>2</sup> quality.
- The support and availability of the listed specifications and functionalities varies depending on operating systems, applications and network protocols as well as network and system configurations.
- The stated life expectancy of each consumable is based on specific operating conditions such as page coverage for a particular page size (5% coverage of A4). The actual life of each consumable will vary depending on use and other printing variables including page coverage, page size, media type, continuous or intermittent printing, ambient temperature and humidity.
- Some of the product illustrations contain optional accessories.
- Specifications and accessories are based on the information available at the time of printing and are subject to change without notice.
- Konica Minolta does not warrant that any prices or specifications mentioned will be error-free.
- All brand and product names may be registered trademarks or trademarks of their respective holders and are hereby acknowledged.

For complete information on Konica Minolta products and solutions, please visit: <https://www.aurora.co.uk/>