



# Revoria Press EC1100

PRODUCT BROCHURE





**EC1100**



# Highly productive and easy to use

## High productivity of 100 ppm on mixed media jobs

The Reveria Press EC1100 achieves high productivity printing of 100ppm on both coated and uncoated paper up to 300g in weight. Even on heavier weight media between 300g and 400g, a high speed is maintained at 80ppm.

## Optional Air Suction Feeder ensures ultra-reliable media handling for all media types

Like an offset feeder, each sheet is picked up and delivered securely by the shuttle head using air suction, improving the paper feeding performance for low quality, textured and coated media. This system is different to most others on the market, giving ultra-reliable and consistent paper feeding and therefore print performance.

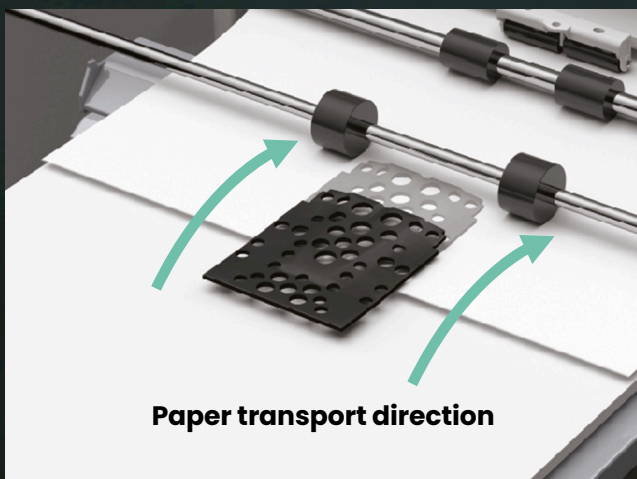



#### **Automation with inline sensor**

The Revoria Press EC1100 has an inline sensor which automatically makes adjustments for a number of critical production parameters, including the image-to-media alignment, image transfer, density uniformity and tone reproduction curve. This saves time, optimises quality and improves the efficiency of production for simple, more reliable operation. This is particularly useful for longer banner paper, which has a tendency to skew or suffer from mis-registration without these automated adjustments.

#### **Optimise print conditions for each paper type with built in media library**

Minimise adjustments when setting up print jobs by using pre-registered paper type settings in the media library such as voltage and curl. Alternatively, you can customise the pre-loaded recommended paper list and save up to 1,000 different paper type setting for faster setup.

#### **Auto sheet clearing after paper jam**

Significantly reduce the time taken to clear a paper jam with the automated clearing of the remaining paper after a jam. When a paper jam does occur, offset pages are inserted to identify any missing or repeated pages.

# Versatile

## Handles various media weights from 52g to 400g

Everything from thin folded flyers to thick business cards can be printed. Additionally, not only can it handle heavier weight longer papers (350g up to 660mm, 300g up to 864mm) but the efficient media handling and versatility mean a wide range of customer needs can be met. In addition, high speed envelope printing can be achieved without an additional fuser.

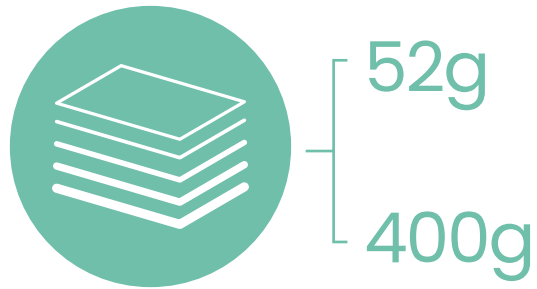



148 x 98 mm

**Wide range of paper sizes, along with long banner paper of 1200 mm**

The printer supports a wide range of paper sizes, from 148 x 98 mm (smaller than a postcard) up to 1200 x 330mm banner paper. The Multi Sheet Inserter for banner printing can print single-sided long paper from 660 x 330mm up to 1200 x 330mm, depending on the configuration, and duplex long paper up to 864 x 330 mm, opening up new application and business opportunities. The Revoria Press EC1100 performs automated alignment adjustments to prevent paper skew or mis-registration which can often occur for longer banner papers to ensure ultra-reliable operation.



1200 x 330 mm

# High

## 10-bit processing and half tone smoothing

10-bit processing results in up to 1024 halftones (instead of 256 with an 8-bit system) meaning extra control and higher quality reproduction can be achieved. In addition, graduation correction is used on images and vector graphics, faithfully reproducing fine tints, gradations of colour and subtle blends between colours. This is especially valuable when printing colour gradients, skin tones and shadows.

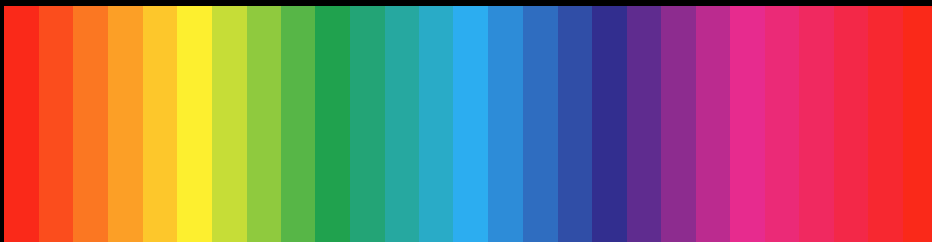

8 bit

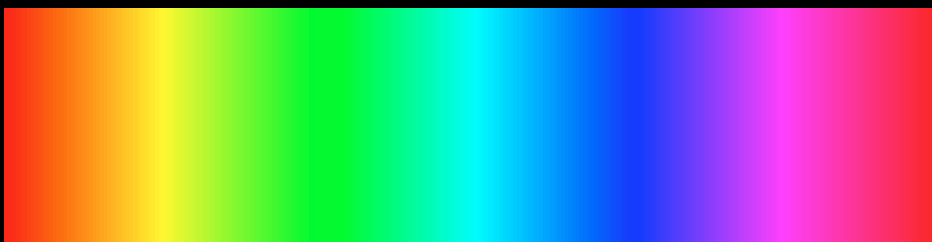

10 bit





# quality

## 2400 dpi resolution and excellent registration

The VCSEL-ROS laser provides 2400 dpi print resolution while the energy-efficient EA-Eco toner\* achieves superb results on either coated or uncoated paper to deliver high quality images comparable to offset printing. In addition, the front/back registration of up to 0.5mm (0.8mm from standard trays) ensures high quality duplex printing.

\* Emulsion Aggregation-Eco Toner

# Advanced technologies



## 1. Control panel

Access settings with ease and view job status and errors with the large 10.1-inch liquid crystal touch panel.

## 2. VCSEL-ROS / EA-Eco toner\*

The VCSEL-ROS provides 2400 dpi print resolution while the energy-efficient EA-Eco toner\* achieves superb results on either coated or uncoated paper to deliver high quality images comparable to offset printing.

\* Emulsion Aggregation-Eco Toner

## 3. Air suction mechanism / multi-feed detection device

The Air Suction Feeder\* is installed with a proprietary air suction mechanism to stabilise a wide variety of paper types for high speed feeding, with the Multi-feed Detection Device ensuring documents are printed accurately.

\* Optional

## 4. Gate-type registration mechanism

This mechanism corrects the tilt of paper moving at high speed and stabilises the paper path.

## 5. Compact belt roll fuser

The compact belt roll fuser provides the uniform heat and pressure needed to fuse images onto a wide variety of paper stocks including heavyweight paper.

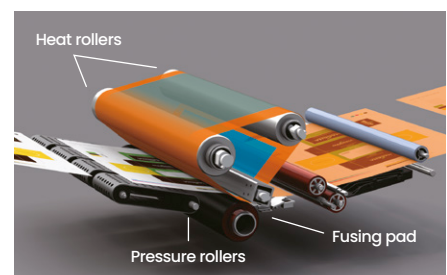

## Dimensions (unit: mm)

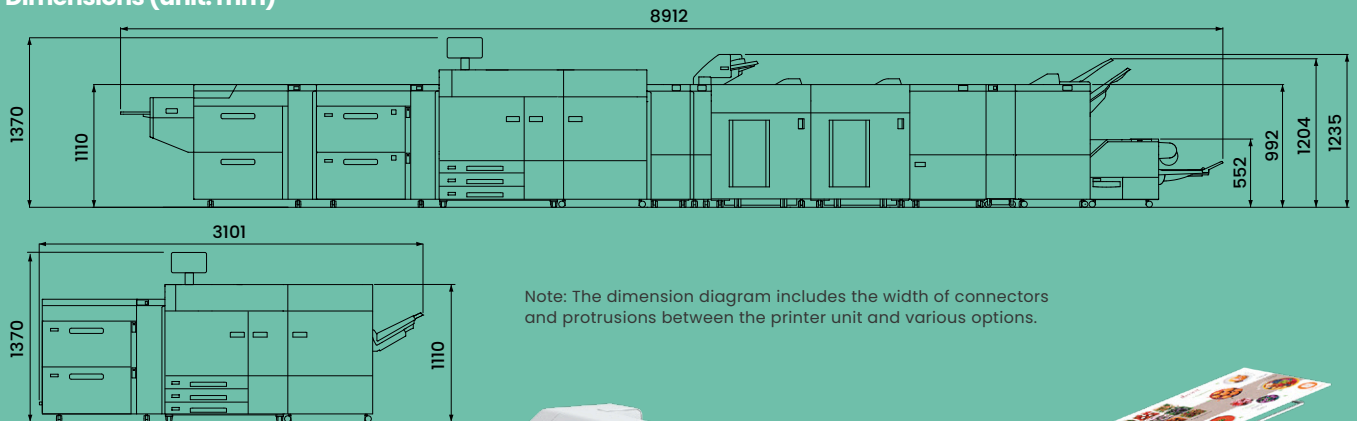

Note: The dimension diagram includes the width of connectors and protrusions between the printer unit and various options.



### 6. Built-in twin decurler

This Revoria Press EC1100 corrects paper curl, preventing problems that can negatively affect the stable transfer of paper from occurring. The amount of correction can be adjusted to match the size and orientation of any type of paper curl.

### 7. Compact paper cooling device

An integral compact paper cooling device improves paper transfer and finishing to help achieve superb, high quality print.

### 8. Inline sensor

Waste no time making adjustments and increasing machine downtime, as the Revoria Press EC1100 has an inline sensor which automates the adjustment of image-to-media alignment, image transfer, density uniformity and tonal reproduction curves.

### 9. Real time curl correction

Adjust the amount of curl in printouts by installing the optional Interface Decurler Module D1.

### Selectable print server: Fiery SC11 and Fiery SC12C

Fiery SC11 and Fiery SC12C are available as print server choices.

# Finishing applications

## Crease / Two-sided Trimmer D2



Crease



Two-sided trim

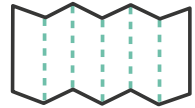

Up to 5 crease lines  
(max. 330x488mm)

## Folder Unit CD2

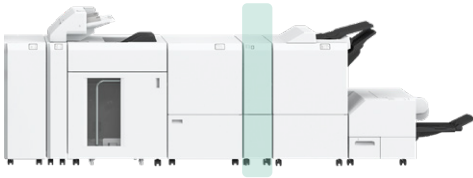

Z fold half sheet

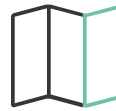

Z fold



Tri-fold

## Finisher D6 with Booklet Maker



Single staple



Dual staple



Single fold



Single fold  
(multiple sheets)



Booklet

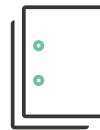

2 hole punch



3 hole punch

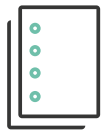

4 hole punch

## Square Back Fold Trimmer D1



Square back



Face trim



**Wide variety of finishing options**

Easily complete jobs from print to finish with the wide variety of automated finishing features of the Revoria Press EC1100. These include A3 cover sheet insertion, punch, staple, saddle staple, single fold, Z fold half sheet/ tri-fold, crease, face trim, full bleed trim, and square back.

# Feeding and finishing options

## Feeding Options (Max. 10760 sheets)\*

\* Main unit + Chained Air Suction Feeder CI-DS-L + Chained Air Suction Feeder CI-DS-R.

### One High Capacity Feeder Configuration



#### High Capacity Feeder C3-DS+ Multi Sheet Inserter for Banner Print

- Air assist • Multi-feed detection
- 2100 sheets x 2 trays maximum A3, 330 x 488 mm + 250 sheets maximum 330 x 660mm
- 52 to 350g



#### Air Suction Feeder CI-DS

- Air suction • Multi-feed detection
- 2200 sheets x 2 trays maximum A3, 330 x 488 mm + 250 sheets maximum 330 x 660mm
- 52 to 400g



#### Air Suction Feeder CI-DSXL\*1 + Banner Unit for Air Suction Feeder CI-DSXL

- 1200 mm Long Paper\*2 • Air suction
- Multi-feed detection
- 900 sheets + 2200 sheets maximum A3, 330 x 1200 mm (upper tray), maximum 330 x 488mm (bottom tray) +250 sheets maximum 330 x 660mm
- 52 to 400g



#### 2nd High Capacity Feeder CI-DS+ High Capacity Feeder C3-DS+ Multi Sheet Inserter for Banner Print

- Air assist • Multi-feed detection
- 2100 sheets x 2 trays x 2 units maximum A3, 330 x 488 mm +250 sheets maximum 330 x 660mm
- 52 to 350g



#### Chained Air Suction Feeder CI-DS-L + Chained Air Suction Feeder CI-DS-R

- Air suction
- Multi-feed detection
- 2200 sheets x 2 trays x 2 units maximum A3, 330 x 488 mm +250 sheets maximum 330 x 660mm
- 52 to 400g



#### Chained Air Suction Feeder CI-DSXL-L\*1 + Chained Air Suction Feeder CI-DS-R + Banner Unit for Air Suction Feeder CI-DSXL

- 1200 mm Long Paper\*2 • Air suction
- Multi-feed detection
- 900 sheets + 2200 sheets x 3 trays, maximum 330 x 1200 mm (upper left tray), 330 x 488mm (rest 3 trays) + 250 sheets maximum 330 x 660mm
- 52 to 400g

Note: The High Capacity Feeder is a required option. Be sure to select a configuration.

\*1: Only the upper tray allows long paper feeding.

\*2: During 1 Sided Printing. Up to 330 x 864 mm during Duplex Automatic Print.

## Output Options (Max. 14500 sheets)\*

\* High Capacity Stacker A1 x 2 + Finisher D6.



#### Offset Catch Tray

- Offset Stack
- Up to 500 sheets



#### Long Catch Tray

- Long paper Stacking



#### Interface Decurler Module D1

- Real Time Curl Correction



#### Inserter D1

- Cover / Sheet Insertion



#### High Capacity Stacker A1

- 5000 sheet of offset stacking
- Available in single and dual combinations
- Stacker cart
- Long paper stacking\*1



#### Crease / Two-sided Trimmer D2

- Two-sided Trim • Crease



#### Folder Unit CD2

- Z Fold Half Sheet
- Tri-Fold



#### Finisher D6 / Finisher D6 with Booklet Maker

- Sort / Stack
- Staple • Punch\*1
- Saddle Staple/Single Fold\*2
- Long Paper Stacking\*1



#### Square Back Fold Trimmer D1

- Face Trim • Square Back

Note: For options and trays that can hold long paper output, please check "Key Specifications". \*1: Optional. \*2: For Finisher D6 with Booklet Maker.

# Key specifications

Item	Description	
<b>Type</b>	Console	
<b>Colour Capability</b>	Full Colour	
<b>Printing Resolution</b>	2400 x 2400 dpi	
<b>Continuous Print Speed<sup>*1</sup></b>	<b>A4</b>	100 ppm
	<b>A3</b>	52 ppm
<b>Paper Size<sup>*2</sup></b>	<b>Tray 1, 2, 3</b>	Standard size: Max A3, 11 x 17", Min A5 Custom size: 140 x 182 mm to 330 x 488 mm
	<b>Bypass Tray (Tray 5)<sup>*3</sup></b>	Standard size: Max A3, 11 x 17", Min A6 Custom size: 98 x 148 mm to 330 x 660 mm
<b>Paper Weight</b>	<b>Tray 1, 2, 3</b>	64 to 256 gsm
	<b>Bypass Tray (Tray 5)<sup>*3</sup></b>	52 to 300 gsm <sup>*4</sup>
<b>Paper Tray Capacity<sup>*5</sup></b>	<b>Standard</b>	570 sheets x 3-tray
	<b>Max</b>	10760 sheets (Standard + Chained Air Suction Feeder C1-DS-R + Chained Air Suction Feeder C1-DS-L)
<b>Output Tray Capacity<sup>*5*6</sup></b>	500 sheets (A3)	
<b>Power Supply</b>	AC200-240 V +/- 10 %, 24 A, 50/60 Hz	
<b>Maximum Power Consumption</b>	5.76 kW	
<b>Dimensions<sup>*7</sup></b>	W 2671 x D 834 x H 1370 mm	
<b>Weight<sup>*7</sup></b>	727 kg	

Note: Multi Sheet Inserter for Banner Print cannot be directly connected to the main unit. It is used by connecting to High Capacity Feeder C3-DS.

\*1 When continuously printing a single document. 52 to 300 gsm, uncoated paper. Print speed may be reduced depending on conditions of output data, on whether auto image quality adjustment is performed, on whether the job includes a mixture of paper sizes and types, and other reasons.

\*2 Image loss width: Lead edge 4.0 mm, Trail edge 2.0 mm, Front 2.0 mm, Rear 2.0 mm.

\*3 Bypass Tray is Multi Sheet Inserter for Banner Print.

\*4 Banner Printing 52 to 220 gsm.

\*5 82 gsm paper.

\*6: Offset Catch Tray.

\*7: Includes main unit and High Capacity Feeder C3-DS. Excludes output tray and external print server.



Fiery software	Description
<b>SC12C</b>	Bundled system: hot folders/virtual printers Fiery Spot-On Fiery JobExpert and PDF processing Kit Fiery FS500 Pro system software
<b>SC11</b>	External system: hot folders/virtual printers Fiery Spot-On JobFlow Base Fiery Impose Fiery JobMaster (5 years license) Fiery FS500 Pro system software.

Please contact your local Fujifilm partner or visit:  
**[print-emea.fujifilm.com/product/revoria-press-ec1100/](http://print-emea.fujifilm.com/product/revoria-press-ec1100/)**

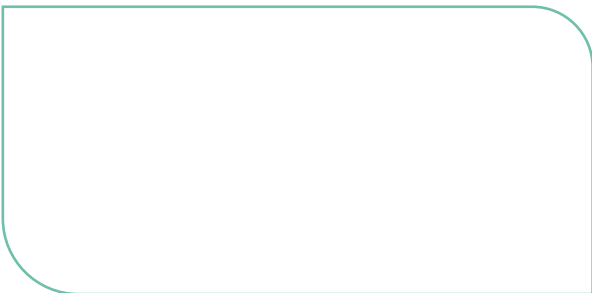

**Fujifilm Print**



**Fujifilm Print**



**@FujifilmPrint**